

The ACM-A95 is an IP65 DIY Fingerprint Lock Kit for home/office use.

It includes a Metal Wireless Fingerprint Keypad+ a Wireless Bolt Lock + a Wireless Exit Button + 2pcs

Remote Transmitters. 433MHz Rolling Code of encryption algorithm and the split design guarantee higher-secure.

ACM--A95

IP65 DIY Fingerprint Lock Kit

- > All wireless, no need wires any more
- > Easy for installation and operation
- > Open times: 16,000 times for lock, 10,000 times for keypad
- > 433MHz Rolling Code technology
- > Ultra low power consumption
- > With two remote transmitters
- > Metal Wireless Fingerprint Keypad (IP65)
- > 1000 Users (including 100 fingerprint users + 900 PIN / card users)
- > 4~6 digits PIN, 125KHz EM card
- > Communication distance: 20M max
- > Open the lock by fingerprint keypad, wireless exit button and remote transmitters
- > Battery life: more than 12 months

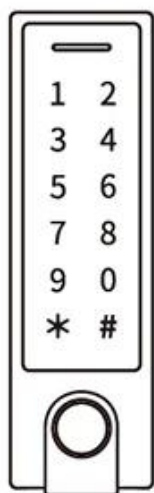

Wireless Fingerprint

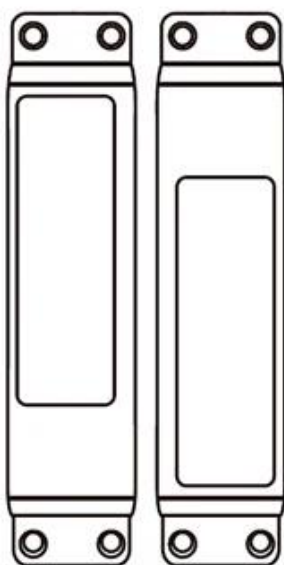

Wireless Lock



Wireless Button



Remote Transmitters

Product Parameter

Parameter Description

Model	ACM-A95
Product Name	IP65 DIY Fingerprint Lock Kit
User Capacity	1000 Users (including 100 fingerprint users + 900 PIN / card users)
PIN Length	4-6 digits
Card Type	125KHz EM card
Operating Voltage	
Wireless Lock	2 units of AA batteries
Wireless Fingerprint Keypad	3 units of AAA batteries
Wireless Exit Button	1 units of 2032 Lithium battery
Remote Transmitter	1 unit of 2032 Lithium battery
Idle Current	All items < 10uA
Working Current	
Wireless Fingerprint Keypad	< 50mA
Wireless Lock	< 42mA
Wireless Exit Button	< 3mA
Remote Transmitter	< 3mA
Communication Frequency	433MHz
Communication Distance	20m Maximum
Working Temperature	Outdoor, IP65 (Fingerprint Keypad)
Operating Temperature	
Wireless Lock	-20°C~+60°C (-4°F~+140°F)
Wireless Fingerprint Keypad	-20°C~+60°C (-4°F~+140°F)
Operating Humidity	0%~86%RH
Physical	
Wireless Lock	Zinc-Alloy
Wireless Fingerprint Keypad	Zinc-Alloy

Others

ABS Shell

Dimensions

Wireless Fingerprint Keypad	L149 * W43.5 * H22 (mm)
Wireless Lock	L170 x W39 x D25(mm)
Wireless Exit Button	L83 x W40 x D16(mm)
Remote Transmitter	L62 x W30 x D11.5(mm)
Unit Weight	780g
Wireless Keypad	300g
Wireless Lock	400g
Wireless Exit Button	30g
Remote Transmitter	25g/pc



Complete Wireless Kit!
DIY Installation

Various Access Modes:
Fingerprint, Card, PIN,
Remote Controls



IP65 Rating for Outdoor

Battery powered, no need
wires anymore



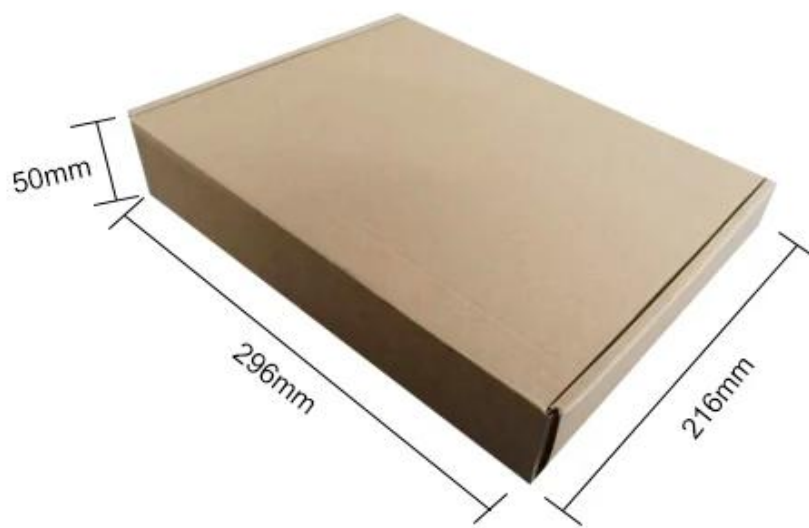

Wireless Fingerprint Keypad: Install by 3M stickers or screws

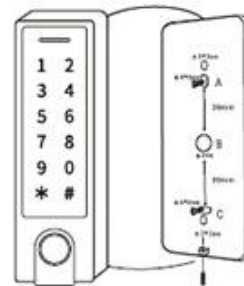
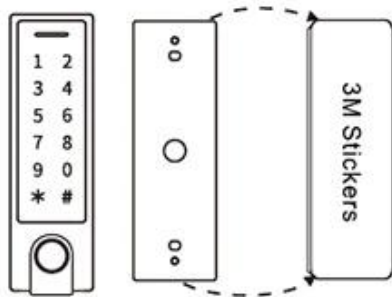

Wireless Lock: Install by screws

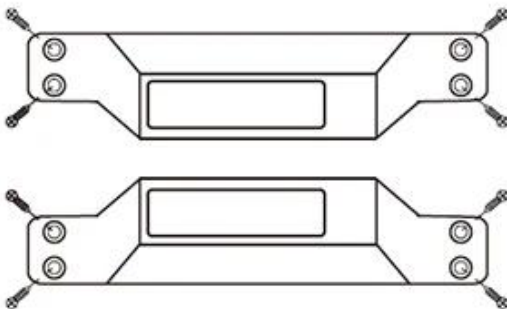

Wireless exit button: Install by 3M stickers

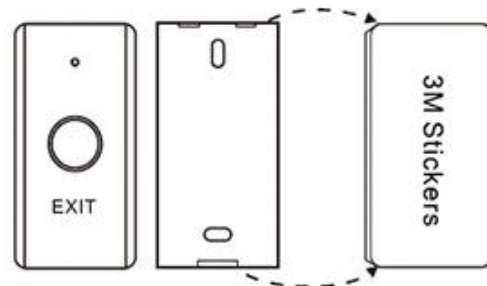

How to release the door ?

(All parts are paired already, Users can operate it directly.)

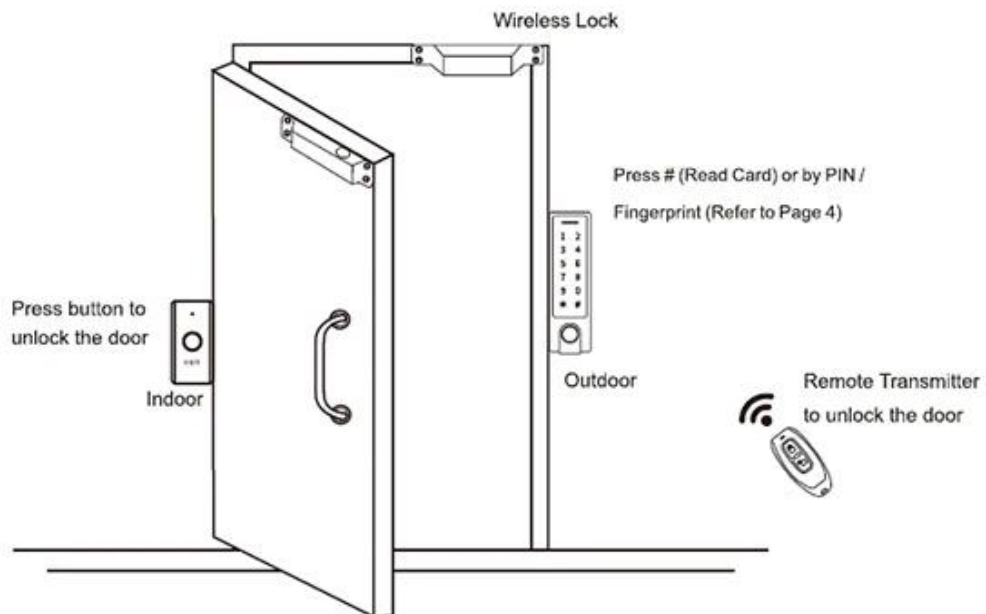

You May Like

We are Professional Access Control Manufacturer, We have Full System for Access Control Product as below:



ACM223

Touch Keypad RFID & Keypad Access Control , 125Khz EM 1000/4000 USer capacity

ACM209-NW

Keypad Metal RFID Single door AccessControl (Non-waterproof), 125Khz EM

ACM208

Waterproof RFID Single door Access Control and Reader



ACM210

Metal RFID Single door Access Control (Non-waterproof)

ACM225

Touch Keypad RFID Access Control, 125Khz EM, Can connect wiegand reader

ACM211B

Touch Keypad Metal case Waterproof
RFID Access Control, Can connect
wiegand reader

Our Service

- 1, Any inquires will be replied within 24 hours
- 2, Professional manufacturer and supplier, Welcome to visit our website and our factory
- 3, OEM/ODM Available
- 4, High quality, fashin desing, reasonable & competitive price, fast lead time
- 5, After-sale Service :
 - 1), All products will have been strictly quality checked in house before packing
 - 2), All products will be well packed before shipping
 - 3), All our products have 2-3 year warranty if the damage is not caused by human
 - 6, Faster delivery : Around 1~ 5 days for sample order, 7~30 days for bulk order
 - 7, Payment : You can pay for the order via : T/T, Western Union, Paypal, Ali trade assurance
 - 8, Shipping: We have strong cooperation with DHL, FEDEX, TNT, UPS, EMS, Forwarder by SEA and By AIR, You also can choose your own shipping forwarder.

FAQ

Q: 1. How can I place an order?

A: Please list your requirement to us via mail. Then we will send the offer to you at earliest time,after order confirmation, we will arrange production ASAP.

Q: 2.What about the payment and shipment?

A: Trade Assurance and T/T ,Paypal, Western Union.
Clients can choose by sea, air or express(DHL, FedEx, TNT UPS etc.)

Q: 3. How can i get a sample to check your quality?

A:We could provide free sample to you, and the freight cost payed by you.

Q:4. How long can I expect to get the samples?

A: It depends on the quantity. Normally 3-7 days for 5000pcs and 7-15 days for 100,000pcs

Q:5. Can your products be customized?

A: Almost all of your products are customized ,including the materia, size, thickness and printing.
OEM orders are highly welcome.

Q:6.Are you a trading company or factory?

We are the one of the biggest manufacturer of RFID cards/NFC tags/RFID keybod /RFID

wristband rfid reader and access control products in China more than 20 years.