

Infrared Sensor Exit Button

Model No: ACM-K846

Material	Metal
Voltage	DC12V
Current	10mA
Sensor distance	5-10CM
Current Rating	3A,36VDC Max
Output	NO, NC, COM
Dimension	86x86mm
Weight	0.14kg

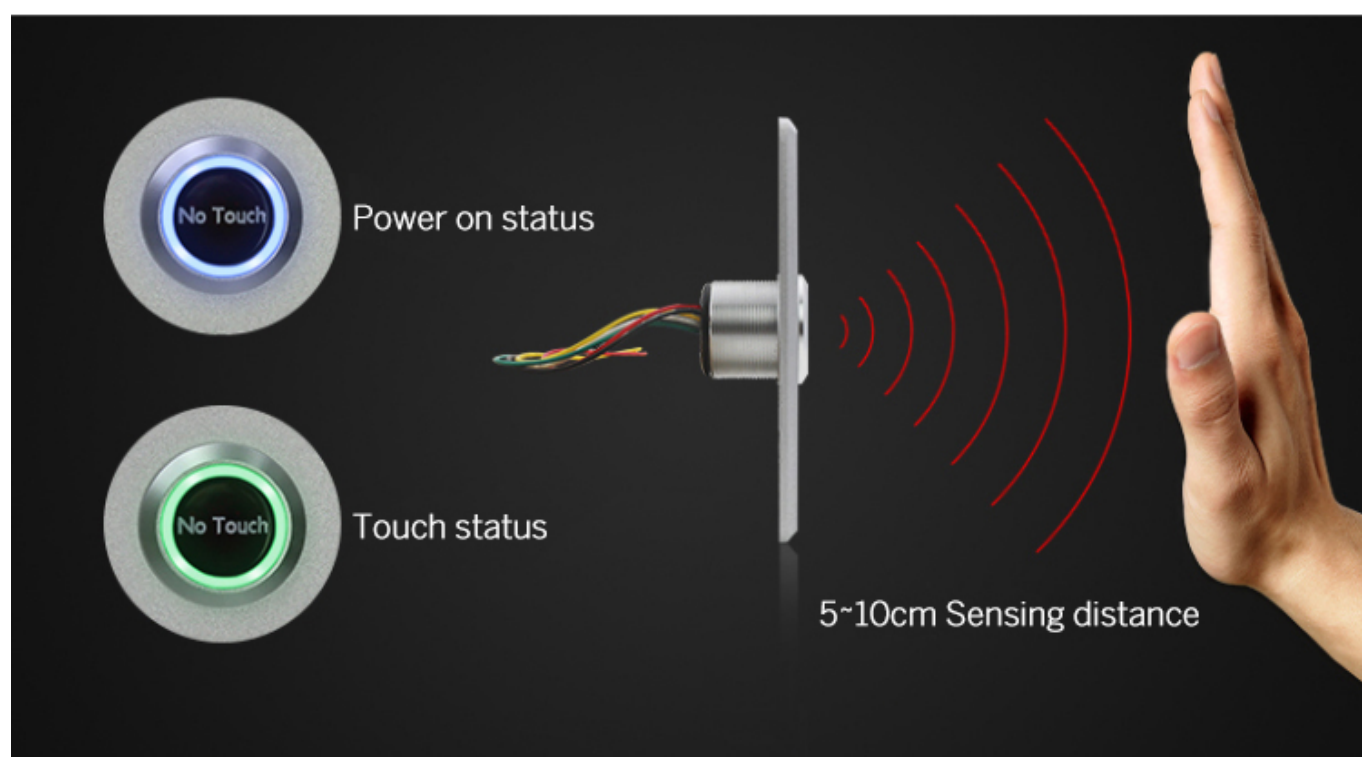

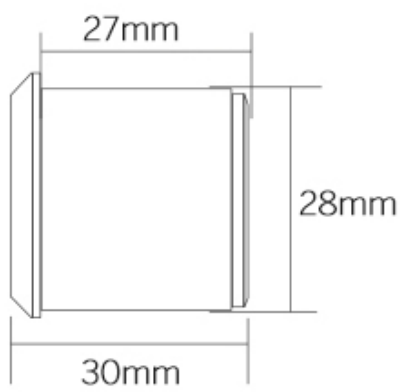
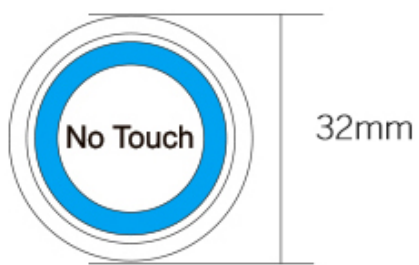

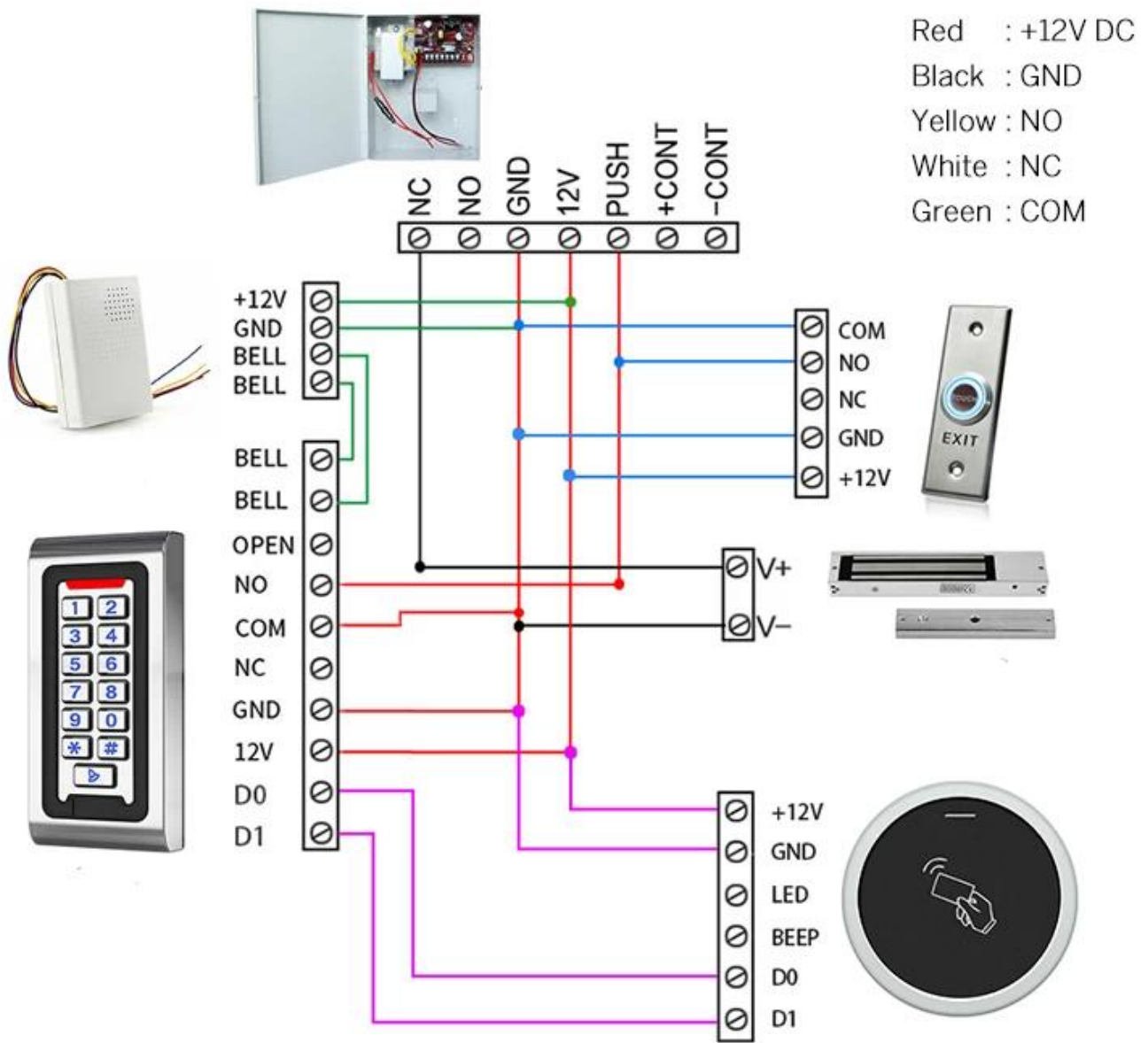

Yours may need

We can supply many kinds of door switches. Touch, No touch, glass break, key switch. Click on the photo above to find more details. Or do not hesitate to send us a request to request the price list.



No touch Door Release Exit Button

K2B: 86 * 86mm

No touch Door Release Exit Sensor

K9A: 115 * 40mm

Door release button, (stainless steel,
NO / NC) K5B: 86 * 86mm





Door release button, (steel, aluminum, NO), K4B: 86 * 86mm
High quality Kirsite made of stainless steel. K14B: 86 * 86mm
PUSH door release button in stainless steel; K815B: 86 * 86mm

Our service

- 1, All inquiries will be answered within 24 hours
- 2, professional manufacturer and supplier, welcome to visit our website and factory
- 3, OEM / ODM available
- 4, high quality, fashion design, reasonable and competitive price, fast delivery time
- 5, after-sales service:
 - 1), All products will have been strictly checked in house before packing
 - 2), All products will be well packed before shipping
 - 3), All of our products have 2-3 years warranty if the damage is not caused by man
- 6, faster delivery : About 1 ~ 5 days for sample order, 7 ~ 30 days for bulk order
- 7, payment: You can pay for the order via: T / T, Western Union, Paypal
- 8, Shipping: We have strong cooperation with DHL, FEDEX, TNT, UPS, EMS, Forwarder by SEA and By AIR, you can also choose your own forwarder.

FAQ

Q: 1. How can I place an order?

A: Please indicate your requirements by email. Then we will send you the offer as soon as possible, after your order has been confirmed, we will arrange the production as soon as possible.

Q: 2. What about payment and shipping?

A: T / T, Paypal, Western Union.

Customers can choose by sea, air or express (DHL, FedEx, TNT UPS etc.)

Q: 3. How can I get a sample to check the quality?

A: We could provide you with free sample and the freight cost paid by you.

Q: 4. How long can I expect to get the samples?

A: It depends on the quantity. Normally 3-7 days for 5000 pieces and 7-15 days for 100,000 pieces

Q: 5. Can your products be customized?

A: Almost all of your products are customized, including material, size, thickness and printing. OEM orders are welcome.

Q: 6. Are you a trading company or a factory?

We are one of the largest manufacturers of RFID cards / NFC tags / RFID keybods / RFID bracelet, RFID reader and access control products in China for over 20 years.